



- Introduction ..... 2
- Important Safeguard ..... 3
- General Features..... 4
- Preparation..... 4
- Location And Function Of Controls..... 5
- How To Operation..... 5
- Attaching(Flush) Consideration..... 6
- Note On Use And Installation..... 6
- System Network..... 7
- Specification..... 8

## User Manual

Multi-Door Color Camera Entry System  
DRC-nAB,nAC

### COMMAX Co.,Ltd.

513-11, Sangdaewon-dong, Jungwon-gu, Seongnam-si, Gyeonggi-do, Korea  
Int'l Business Dept. : Tel.; +82-31-7393-540~550 Fax.; +82-31-745-2133  
Web site : [www.commax.com](http://www.commax.com)

Printed In Korea / 2010.03.101

[www.commax.com](http://www.commax.com)

### COMMAX Co.,Ltd.



- Thank you for purchasing COMMAX products.
- Please carefully read this User's Guide (in particular, precautions for safety) before using a product and follow instructions to use a product exactly.
- The company is not responsible for any safety accidents caused by abnormal operation of the product.

# Introduction

Your unit is designed so it can be flush mounted / attached on the wall or used. When flush mounted / attached on the wall, the stand permits you to the unit for angular of unit view. The model number is located on the bottom and record the serial number in the space provided below (available). Refer to these numbers whenever you call upon your Commax dealer regarding this product.

Model No. \_\_\_\_\_

Serial No. \_\_\_\_\_

**To prevent fire or shock hazard, do not expose the unit to rain or moisture.**

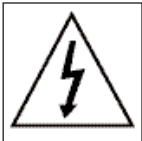
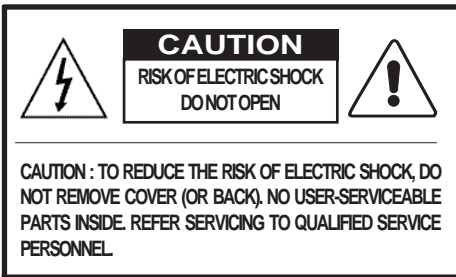

This symbol is intended to alert the use to the presence of uninsulated "Dangerous Voltage" within the product's enclosure that may be of sufficient magnitude to constitute a risk of electric shock to persons.



This symbol is intended to alert the user to the presence of important operating and maintenance (servicing) instructions in the literature accompanying the appliance.

COMMAX COMPANY LIMITED

All Rights Reserved

COMMAX is Trademark and Registered of commax co., ltd. and accessories are manufactured by COMMAX Co., Ltd.

## Important Safeguard

**Damage Requiring Service** - This equipment from the power source and refer servicing to qualified service personnel under the following conditions:

- a. when the power is damaged;
- b. if liquid has been spilled or objects have fallen into the unit;
- c. if the equipment has been exposed to rain or water;
- d. if the equipment has been dropped or otherwise damaged;
- e. when the equipment exhibits a distinct change in performance - this indicates a need for service.

**Water and Moisture** - Do not use this product near water, for example, near a bath tub, wash bowl, kitchen sink, or laundry tub, in a wet basement, or near a swimming pool, and the like.

**Accessories** - The product may fall, causing serious injury to a child or adult, and serious damage to the appliance. Any mounting of the appliance should follow the manufacture's instructions, and should use a mounting accessory recommended by the manufacturer.

**Object and Liquid Entry** - Never push objects of any kind into this product through openings as they may touch dangerous voltage points or shirt-out parts that could result in a fire or electric shock. Never spill liquid of any kind on the product.

**Lightning** - For added protection for this product before a lightning storm, or when it is left unattached and unused for long periods of time, unplug it from the wall outlet and disconnect the other system. This will prevent damage to the product due to lightning and power-line surges. Be sure your antenna is properly ground. If you live in an area heavily prone to lightning storms, it is recommended that you invest in power-line, telephone-line, RF cable and actuator/polarization surge protectors to protect your appliance system from possible damage.

**Servicing** - Do not attempt to service this product yourself as opening or removing covers may expose you to dangerous voltage or other hazards. Refer all servicing to qualified service personnel

**Replacement Parts** - When replacement parts are require, be sure the service technician has used replacement parts specified by the manufacturer or having the same characteristics as the original part. Unauthorized substitutions may result in fire, electric shock or other hazards.

**Safety Check** - Upon completion of service or repairs to this product, ask the service technician to perform safety checks to determine that the product is in proper operating condition.

**Power Line** -The commax door entry system should not be located near overhead power lines or other electric light or power circuits, or where it can fall into power lines or circuits. When installing a door entry system, avoid dangerous contact with power lines or circuits.

**Attachment** - Do not use attachments not recommended by the product manufacturer as they may cause hazards.

**Power Sources** - This equipment should be operated only from the type of power source indicated on the marking label.

## General Features

There is no where better than entry door home system, to make your house door entry home commax door Camera entry system are here to provide positive entry door camera system and convenience life.

- Aluminium material prevent corrosion-strong construction is achieved by thick aluminium plate
- Easy installation and gracefulness design
  - hinge for downward opening of the front plate and retaining lead
  - contract buttons on the front plate
- Capable of multi- installation for sub-units.
- Designed flush mount on the wall type.
- A few number of components
- Easy Assembly
- Front panel suitable for both audio and video systems

## Preparation

- On Safety**
- For DC operation, operate the unit on 12V DC 160mA
  - Should any solid object or liquid fall into the cabinet, disconnected the unit and have it checked by qualified personnel before operating it any further.
  - Allow adequate air circulation to prevent internal heat build-up.

- On Installation**
- Do not place the unit on surfaces (rugs, blankets,etc) or near materials(curtains, drapereis) that may block the ventilation slots.
  - Do not install the unit near heat sources such as radiators or air ducts or in a place subject to direct sunlight, excessive dust, mechanical vibration or shock.

- On Operating**
- Keep the unit and glass away from equipment with strong magnets, such as a microwave oven or large loudspeakers.- When the unit is not in use, turn off the power to conserve energy and to extend its useful life.

- On Cleaning**
- Clean the cabinet, glass and controls with a dirt soft cloth, or a soft cloth lightly moistened with mild detergent solution.
  - Do not use any type of solvent, such as alcohol or benzene, which might damage the finish.

If you have any questions about this unit, contact your Commax dealer.

## Location And Function of Control

Front View

Rear View

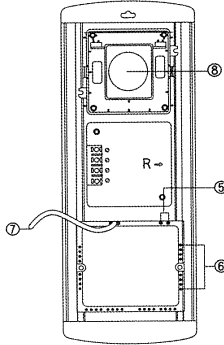
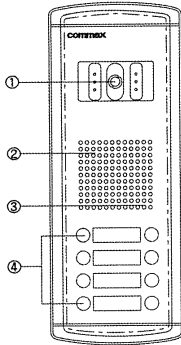

- ① CCD Camera Lens
- ② Speaker
- ③ Microphone
- ④ Resident Calling Buttons
- ⑤ Power Connection (DC12V)
- ⑥ Resident Videophone Connection Connector
- ⑦ Release Connection Wire (Black)
- ⑧ Angular Adjust

Front View

Rear View

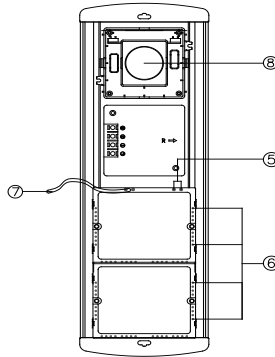
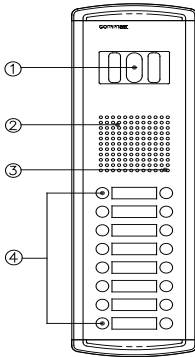

1. CCD Camera Lens
2. Speaker
3. Microphone
4. Resident Calling Buttons
5. Power Connection(DC12V)
6. Resident Videophone Connection Connector
7. Release Connection Wire(Back)
8. Angular Adjust

## How To Operation

### Calling to desired residents on the common door

- When a visitor press a button on the panel, the monitor will show the picture of the visitor who is calling.
- If you conversation with wishes, picking up the handset with the conversation may be started.
- Turn on the [OPEN] button for opening during communicating with the visitor.
- Door camera entry system that 4 wires polarity

## Attaching (Flush) Consideration

**When selecting the location for flush / attaching your unit, please remember...**

- Allow adequate space on the both side of the unit for proper ventilation access to cable and unit for aural easy.
- For angular field of camera view adjust by manually be sure there is sufficient space behind the unit to adjustment to angular field of view its position.
- The area directly below the unit should not be used for cooking radiator or by other appliances generating heat or steam.  
Keep in mind your normal work pattern especially the use of other counter top electrical appliances.

## Attaching (Flush) Consideration

**When selecting the location for flush / attaching your unit, please remember...**

- Allow adequate space on the both side of the unit for proper ventilation access to cable and unit for aural easy.
- For angular field of camera view adjust by manually be sure there is sufficient space behind the unit to adjustment to angular field of view its position.
- The area directly below the unit should not be used for cooking radiator or by other appliances generating heat or steam.  
Keep in mind your normal work pattern especially the use of other counter top electrical appliances.

# System Network

1. For DC operation, operate the unit on 12V DC.
2. Make sure that checking to polarity before wire connection.
3. For installation to residents videophone, camera power supply that connection CC1, CC2 jumper wire on P.C.B (No need supply to camera power 12V).

**Notice : Do not make any wire connections to these terminals while the unit is connection with standard wires.**

**Attention : Make sure that check the DC 12V or other wires.**

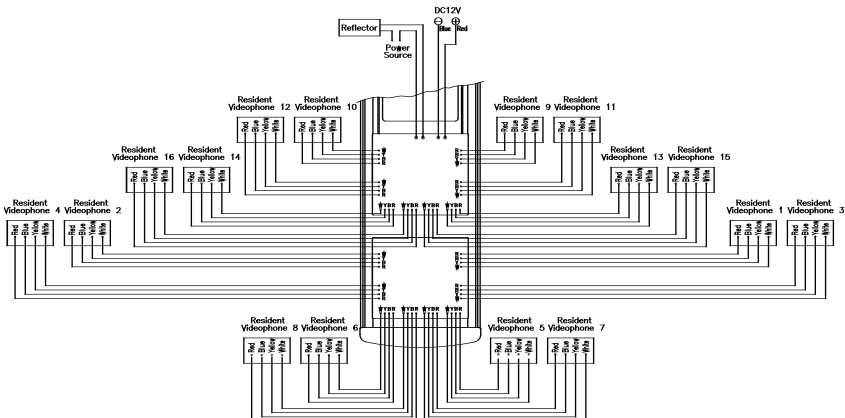
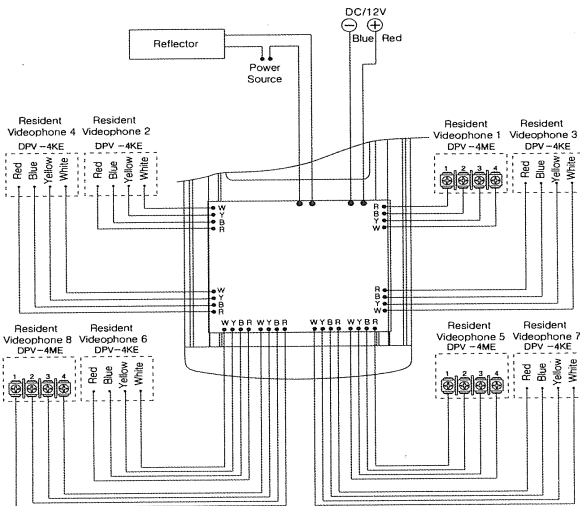

## Specification

Model No.	DRC- nAB	DRC-nAC
Image Device	1/3" CCD Camera	1/4" CCD Camera
Power Sources	DC 12V 160mA	
Installation System	4 wires each - Polarity & videophone(maximum)	
Communication Ways	Synchronous Communications	
Scene Illumination	0.1 Lux (300mm from the camera)	0 LUX
Scanning Frequency	Horizontal : 15.75KHz    Vertical : 60Hz	
Image Angular	Horizontal : 68 °    Vertical : 55°	
Angular Adjust	Left : 13 °    Right : 13° Up : 4 °    Down : 4°	
Ambient Operating Temperature	-10℃ ~ +40℃	
Dimensions (W/H/D)mm	123/320/61	

External design, features, functions and specifications can be changed without any prior, for promoting the quality of the product.



**Memo**